



SHANGHAI
BOJIN MEDICAL
MEDICAL TOOLS



www.bojin-medical.com

L = length [mm]

W = width [mm]

T = thickness [mm]

D = diameter [mm]

CODE: BJ 90 22 1.27 A

↓ ↓ ↓ ↓ ↓
[type] [L] [W] [T] [A/B/G]



A - type teeth



B - type teeth



G - type teeth

Saw blade(Bojin)

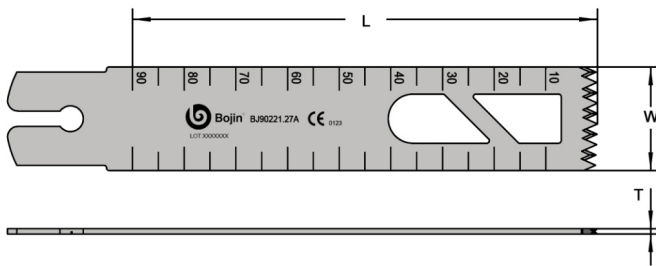

CODE: BJ L W T A/B/G

L	110	100	90	70
---	-----	-----	----	----

W	22	18	14
---	----	----	----

T	1.37	1.27	1.2	1.0	0.9	0.8	0.7
---	------	------	-----	-----	-----	-----	-----

Saw blade(Stryker)

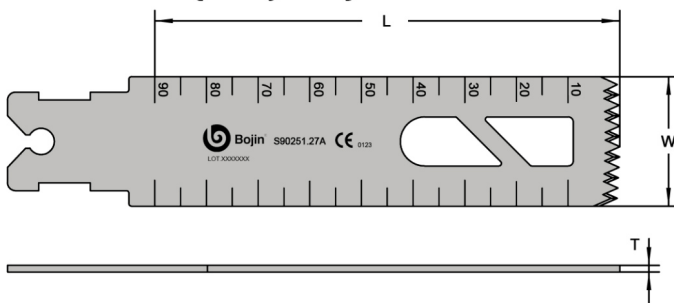

CODE: S L W T A/B/G

L	110	100	90	70
---	-----	-----	----	----

W	22	18	14
---	----	----	----

T	1.37	1.27	1.2	1.0	0.9	0.8	0.7
---	------	------	-----	-----	-----	-----	-----

Saw blade(Stryker)

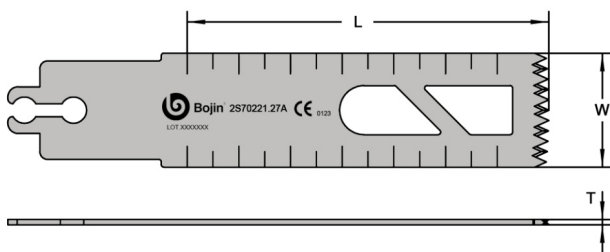

CODE: 2S L W T A/B/G

L	110	100	90	70
---	-----	-----	----	----

W	22	18	14
---	----	----	----

T	1.37	1.27	1.2	1.0	0.9	0.8	0.7
---	------	------	-----	-----	-----	-----	-----

Saw blade(Linvatec)

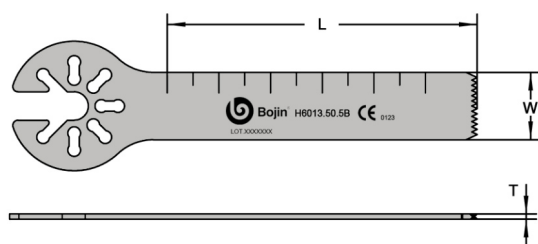

CODE: H L W T A/B/G

L	110	100	90	70
---	-----	-----	----	----

W	22	18	14
---	----	----	----

T	1.37	1.27	1.2	1.0	0.9	0.8	0.7
---	------	------	-----	-----	-----	-----	-----

Saw blade(Synthes)

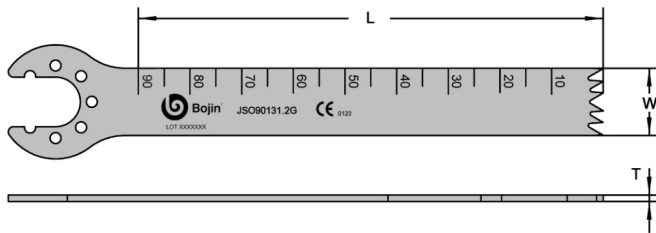

 CODE: JS0 L W T A/B/G

L	110	100	90	70
---	-----	-----	----	----

W	22	18	14
---	----	----	----

T	1.37	1.27	1.2	1.0	0.9	0.8	0.7	0.5	0.3
---	------	------	-----	-----	-----	-----	-----	-----	-----

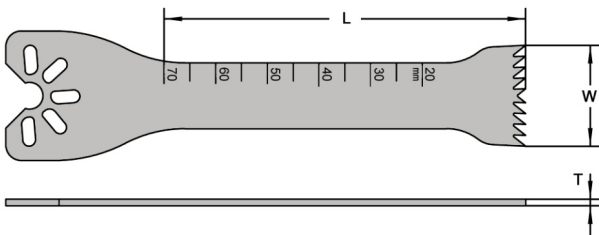
Saw blade(Microair)



 CODE: M L W T A/B/G

L	110	100	90	70
---	-----	-----	----	----

W	22	18	14
---	----	----	----

T	1.37	1.27	1.2	1.0	0.9	0.8	0.7
---	------	------	-----	-----	-----	-----	-----

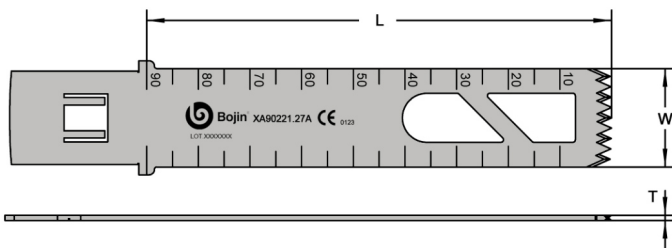
Saw blade(Aesculap)



 CODE: XA L W T A/B/G

L	110	100	90	70
---	-----	-----	----	----

W	22	18	14
---	----	----	----

T	1.37	1.27	1.2	1.0	0.9	0.8	0.7
---	------	------	-----	-----	-----	-----	-----

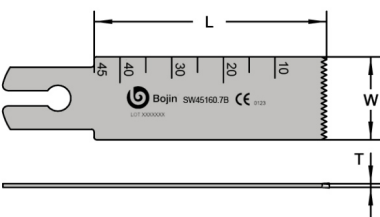
Saw blade(Bojin system 8000)



 CODE: SW L W T B

L	55	50	45	35
---	----	----	----	----

W	16	14	9.5
---	----	----	-----

T	0.7	0.5	0.3
---	-----	-----	-----

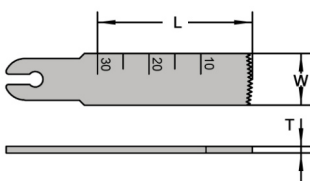
Saw blade(Bojin system 3000)



 CODE: BJ3301 - L W T

L	30	18
---	----	----

W	15	10	8
---	----	----	---

T	0.3
---	-----

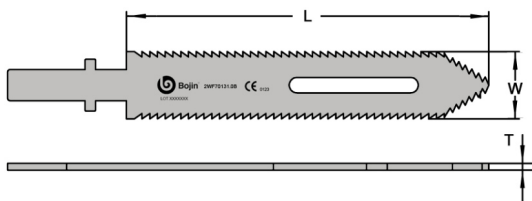
Reciprocating saw blade



 CODE: 2WF L W T A/B

L	90	70	50
---	----	----	----

W	13	7
---	----	---

T	1.0	0.8
---	-----	-----

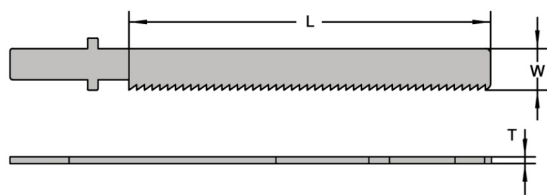
Reciprocating saw blade



 CODE: WF L W T A/B

L	90	70	50
---	----	----	----

W	13	7
---	----	---

T	1.0	0.8
---	-----	-----

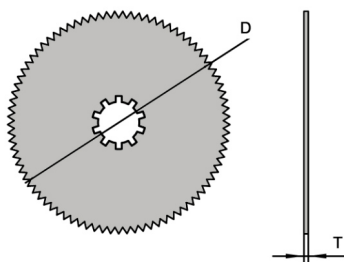
Cutting saw blade

 CODE: SG D T B

D	94	64	51	43
---	----	----	----	----

T	0.8
---	-----

Cutting saw blade

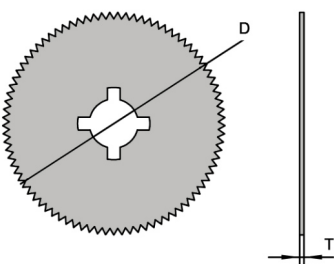
 CODE: SSG D T B

D	94	64	51	43
---	----	----	----	----

T	0.8
---	-----

Cutting saw blade

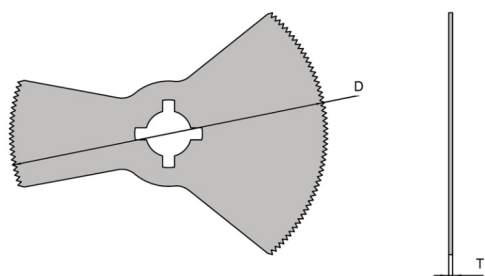
 CODE: SSG D T B

D	64	43
---	----	----

T	0.8
---	-----

Cutting saw blade

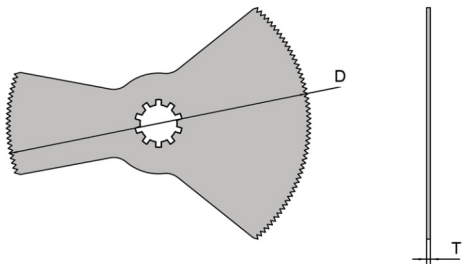

SG D T B

D	94	51
---	----	----

T	0.8
---	-----

TPLO blade

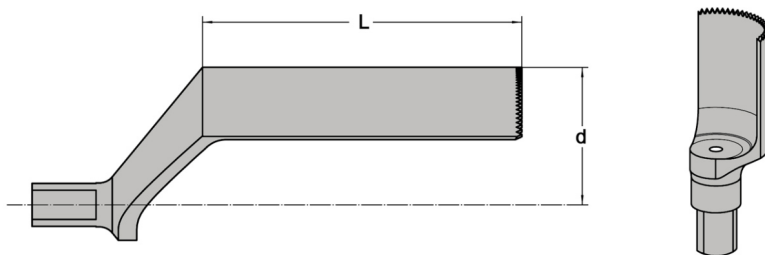

L	25	35	44	47	55
---	----	----	----	----	----

d	R10	R12	R15	R18	R21	R24	R27
---	-----	-----	-----	-----	-----	-----	-----

R30	R33
-----	-----

Overhaul saw blade

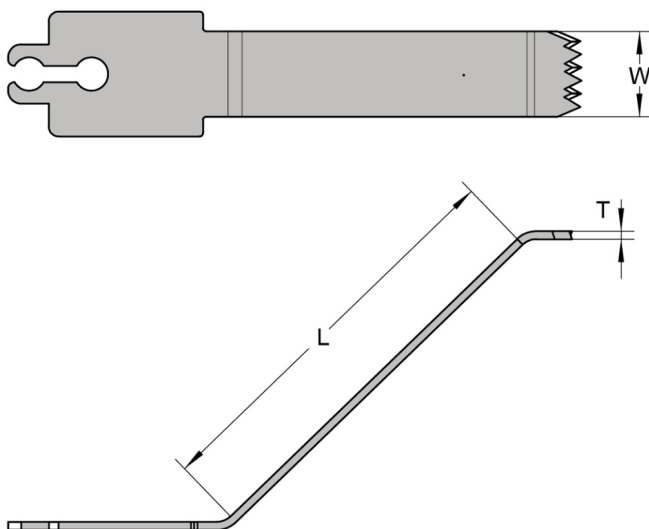

BJF L W T A/B/G

L	100	90	70	59
---	-----	----	----	----

W	25	13
---	----	----

T	1.37	1.27	1.2	1.0
---	------	------	-----	-----

Cranial drill bit

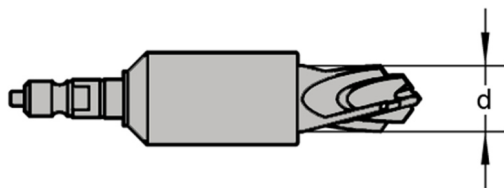

CODE: BJP007

d	Φ4	Φ5	Φ6	Φ8	Φ9	Φ10	Φ11	Φ12	Φ13
---	----	----	----	----	----	-----	-----	-----	-----

Twist drill bit

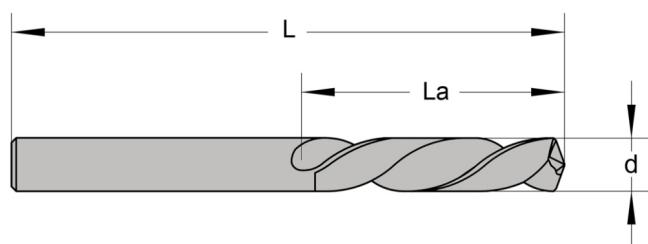

CODE: BJ11021

L	115
---	-----

La	35
----	----

d	Φ2.5	Φ2.7	Φ3.2	Φ3.5	Φ4	Φ4.5
---	------	------	------	------	----	------

AO drill bit

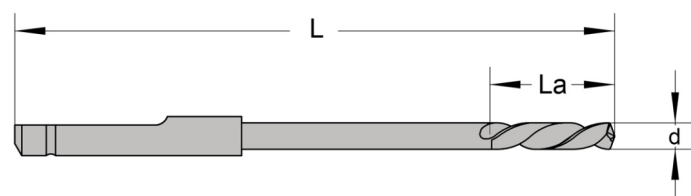

CODE: BJ41021SAO

L	125
---	-----

La	25
----	----

d	Φ2.5	Φ2.7	Φ3.2	Φ3.5	Φ4	Φ4.5
---	------	------	------	------	----	------

Cutting drill bit

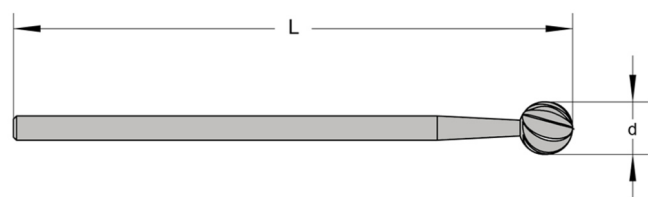

CODE: BJ32011

L	110	70	45
---	-----	----	----

d	Φ1	Φ2	Φ3	Φ4	Φ5	Φ6
---	----	----	----	----	----	----

Diamond drill bit

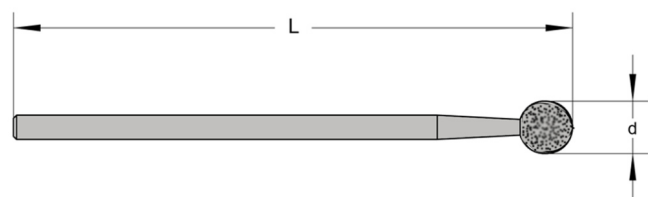

CODE: BJ32012

L	110	70	45
---	-----	----	----

d	Φ1	Φ2	Φ3	Φ4	Φ5	Φ6
---	----	----	----	----	----	----

Milling

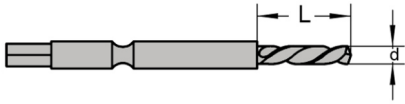
CODE: BJ340210 - d - L

L	4	5	6	8	10	12	14
d	Φ1	Φ1.1	Φ1.5	Φ1.8			

Medullary reamer

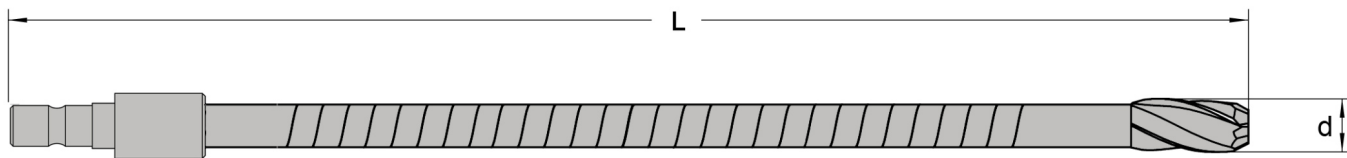

BJ1 103B1

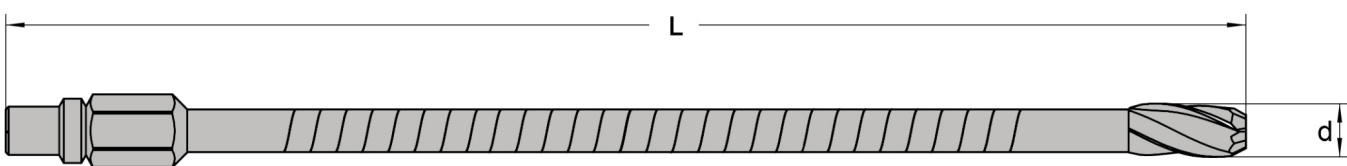

BJ1 103D1

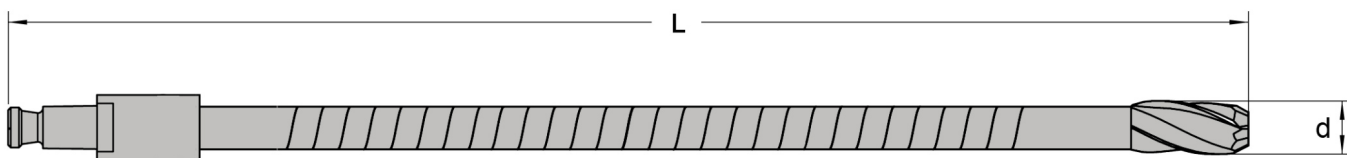

BJ1 103S1

L	250	470
---	-----	-----

d	ø7	ø7.5	ø8	ø8.5	ø9	ø9.5	ø10	ø10.5	ø11	ø11.5	ø12	ø12.5	ø13	ø13.5	ø14	ø14.5	ø15	ø15.5	ø16	ø16.5
---	----	------	----	------	----	------	-----	-------	-----	-------	-----	-------	-----	-------	-----	-------	-----	-------	-----	-------

Quick release reamer



BJ1 103B5

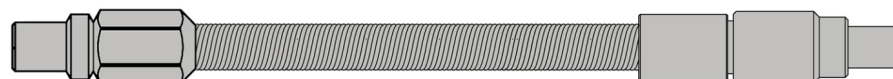

BJ1 103D5

Acetabulum reamer

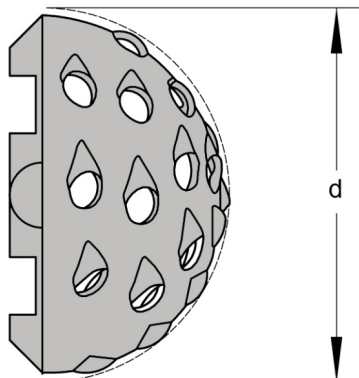

BJ1 107B1

d	φ36	φ38	φ40	φ42	φ44	φ46
	φ48	φ50	φ52	φ54	φ56	φ58
	φ60	φ62	φ64	φ66	φ68	φ70

Reamer shaft

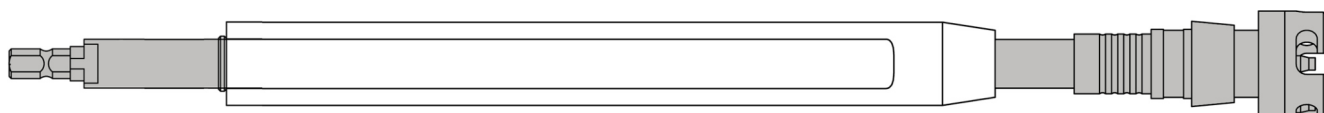

BJ1 107B1T

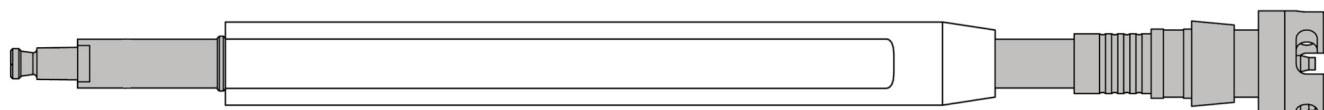

BJ1 107S1T

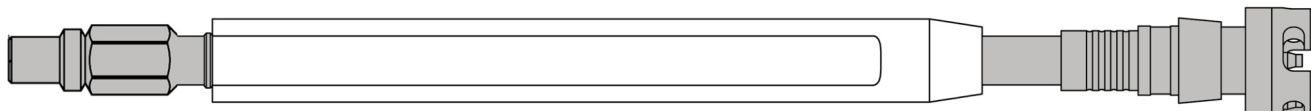

BJ1 107D1T

Reamer shaft

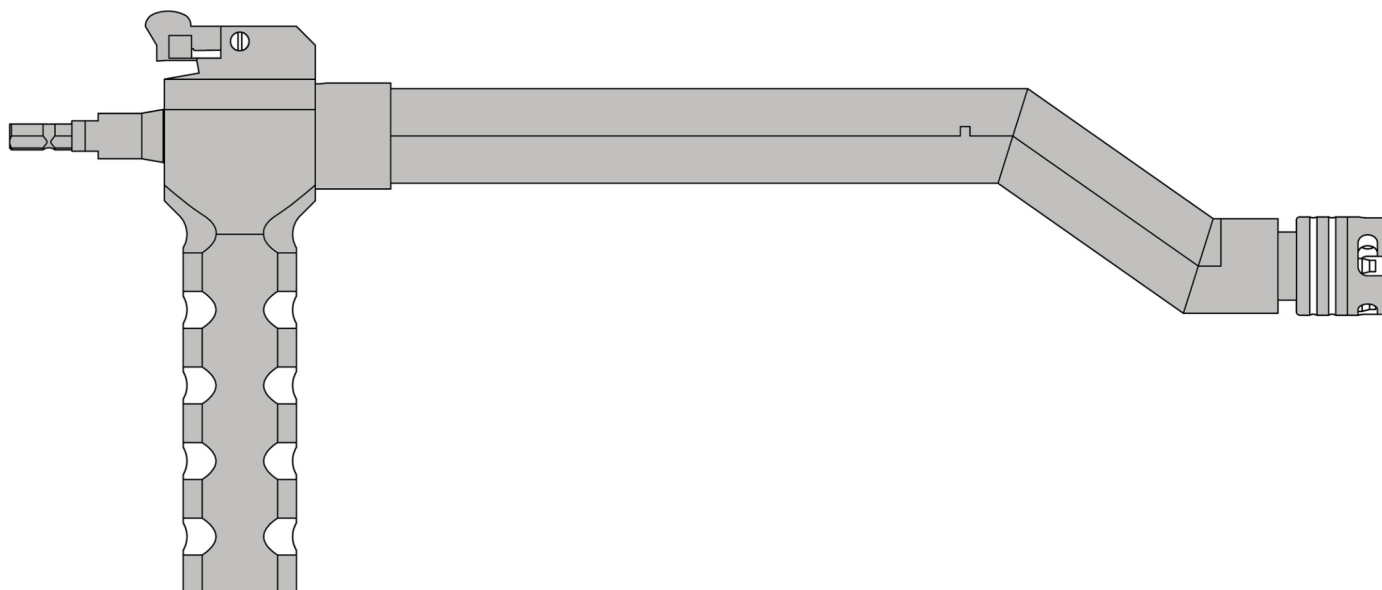

Acetabulum reamer(EPM)

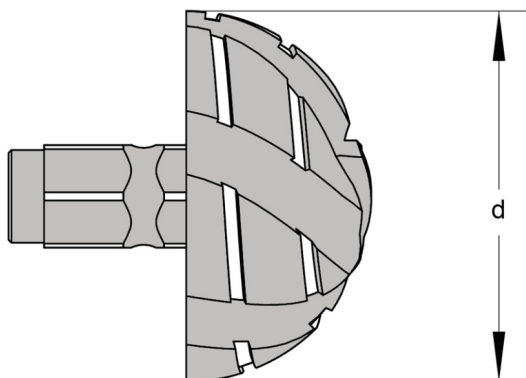

BJ1 107-2

d	φ18	φ19	φ20	φ21	φ22	φ23
	φ24	φ25	φ26	φ27	φ28	
	φ36	φ38	φ40	φ42	φ44	φ46
	φ48	φ50	φ52	φ54	φ56	φ58
	φ60	φ62	φ64	φ66	φ68	

Reamer shaft(EPM)

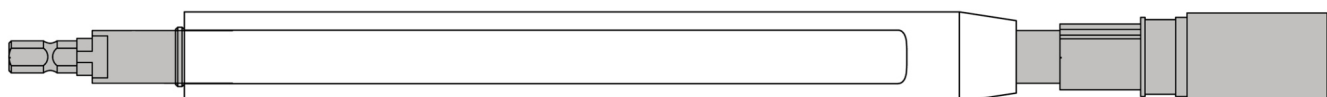

BJ1 107B2T

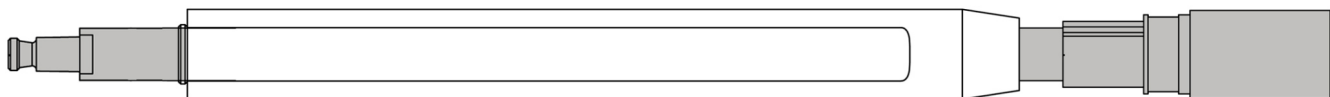

BJ1 107S2T

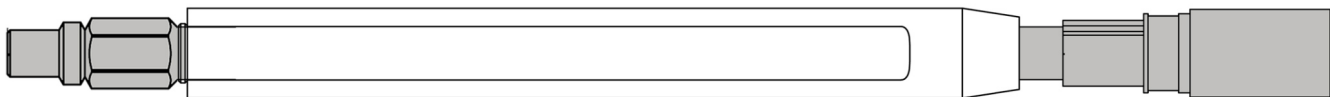

BJ1 107D2T

Reamer shaft(EPM)

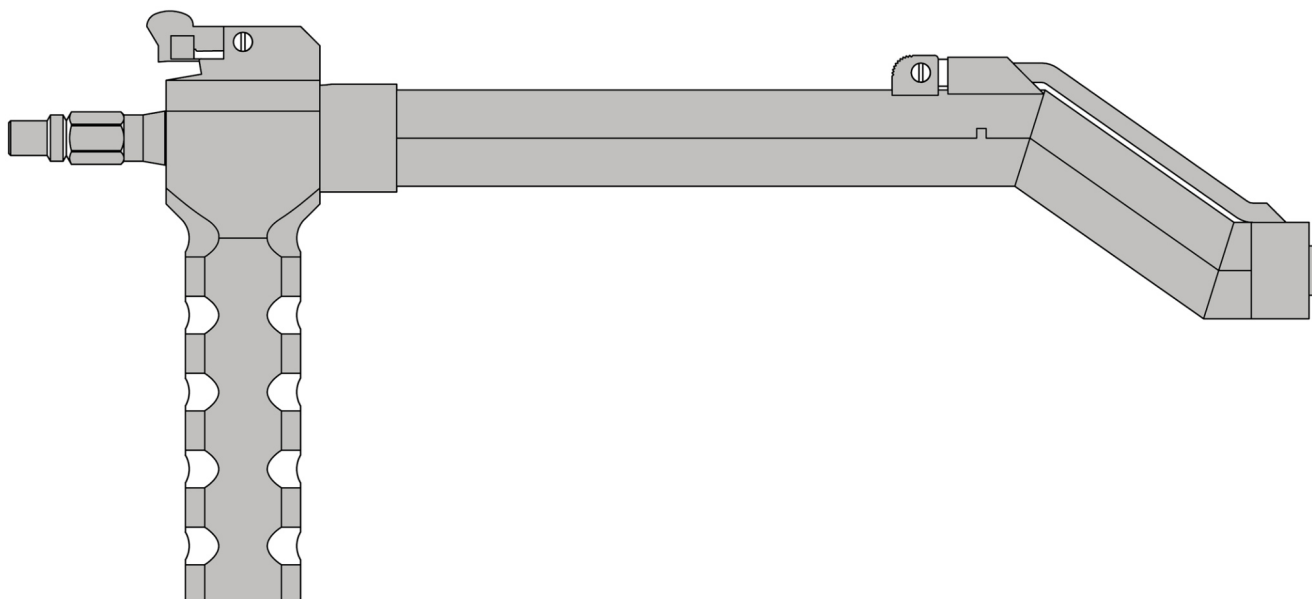

Sterilization case

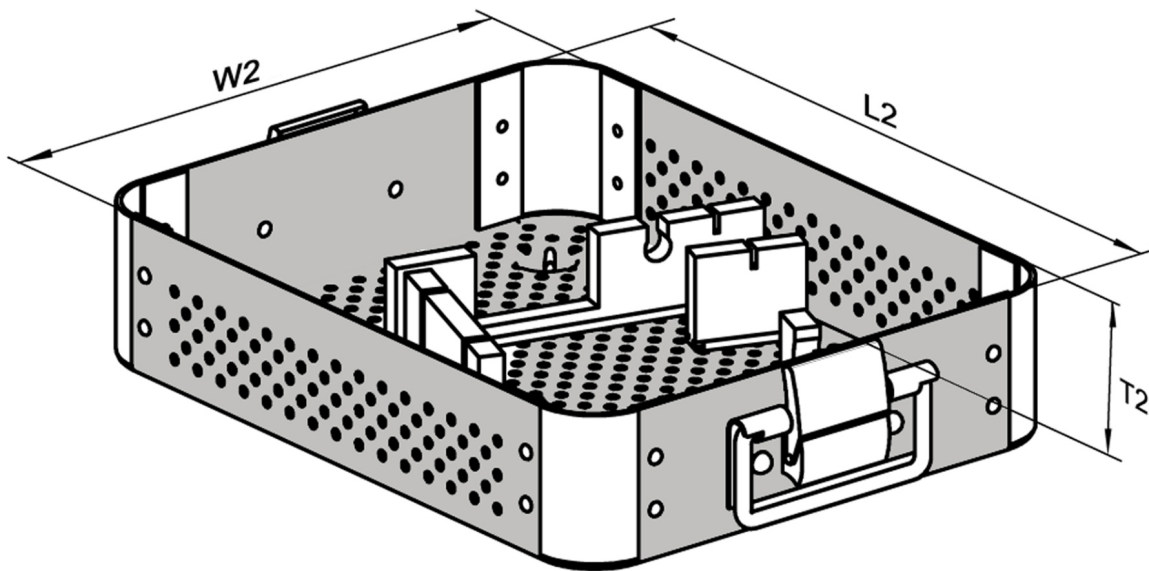
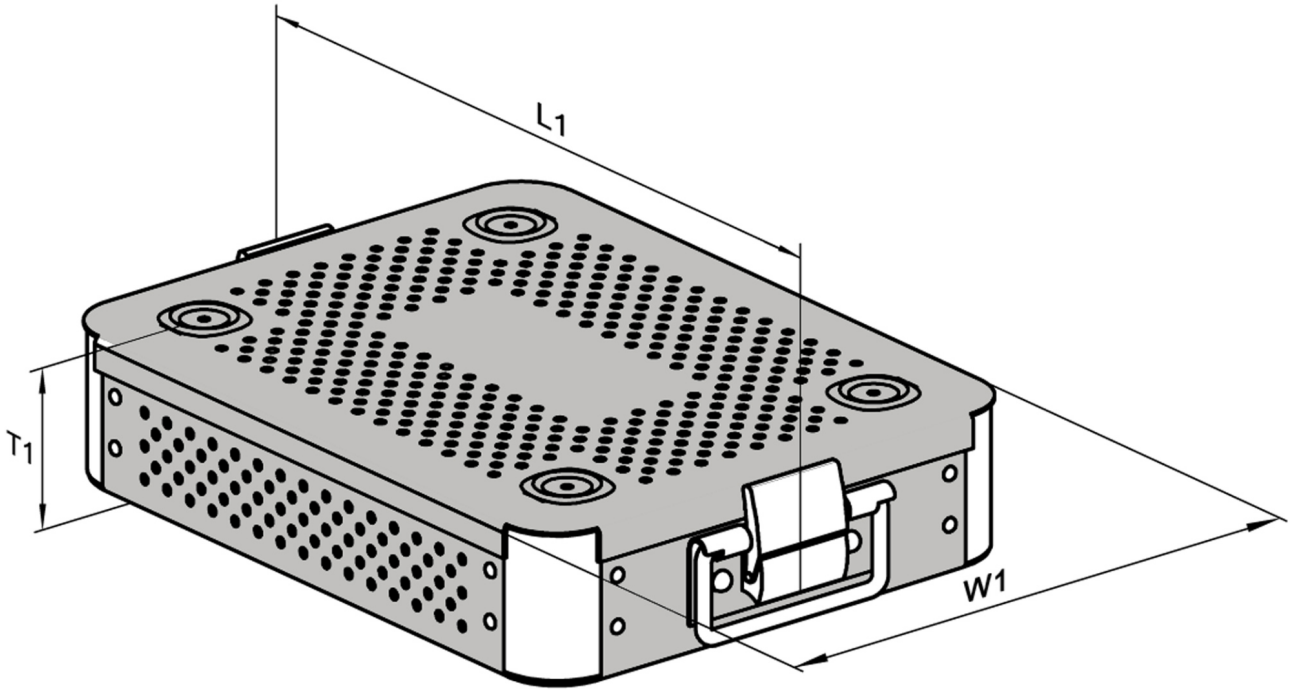

* Sterilization case can be customer made.



Room 606, No. 3388, Gonghexin Road, Shanghai, China
Tel: +86-21-66308078 66308077
Fax: +86-21-66527863
manager@bojin-medical.com
www.bojin-medical.com